

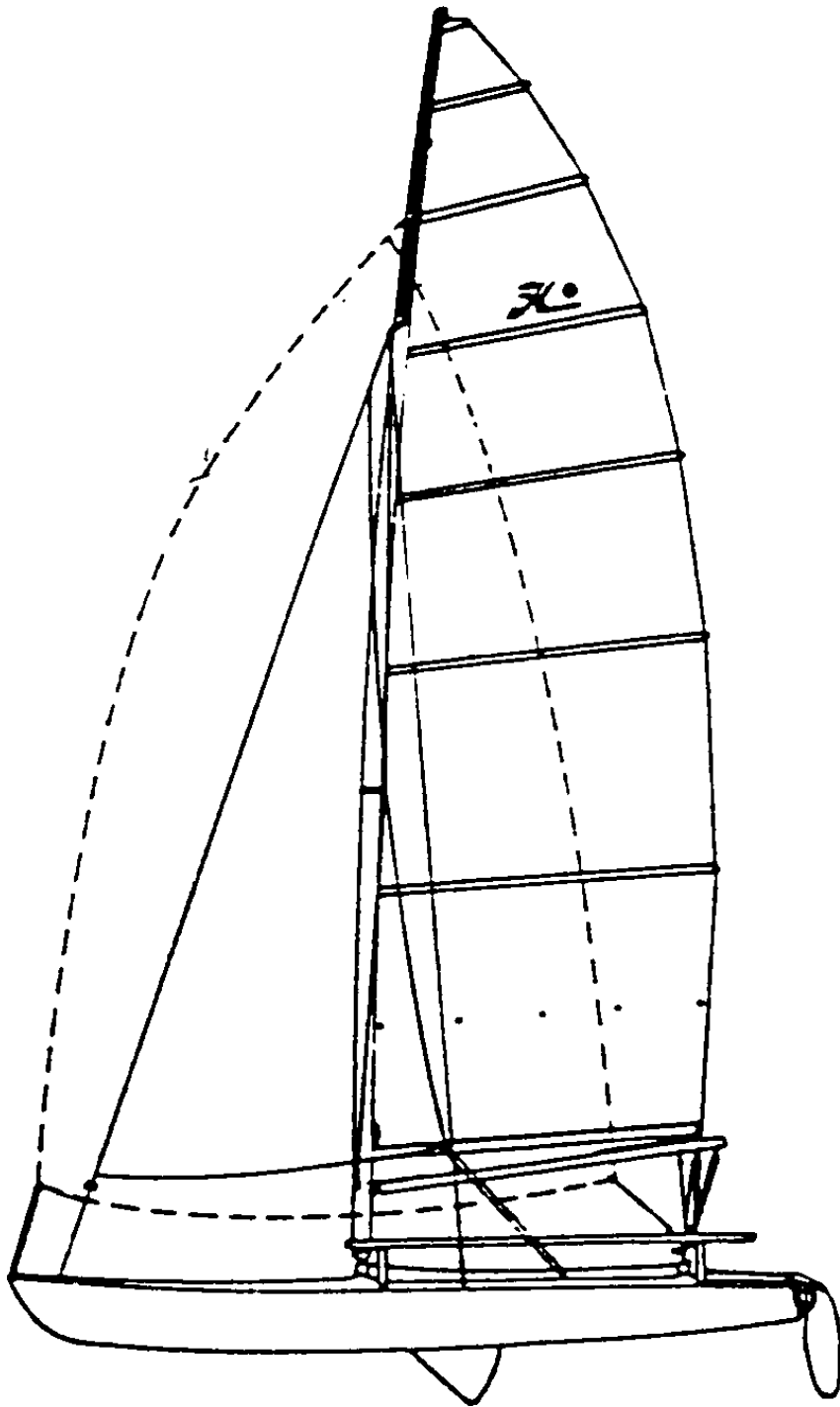

21

Eclaté des pièces détachées

Illustrated Part Guide - Explosionszeichnung



HC 21

Coque/Hull/Rumpf

21056110 : Coque gauche
Left hull
Rumpf links

21056120 : Coque LE droite
LE hull right
Rumpf LE rechts

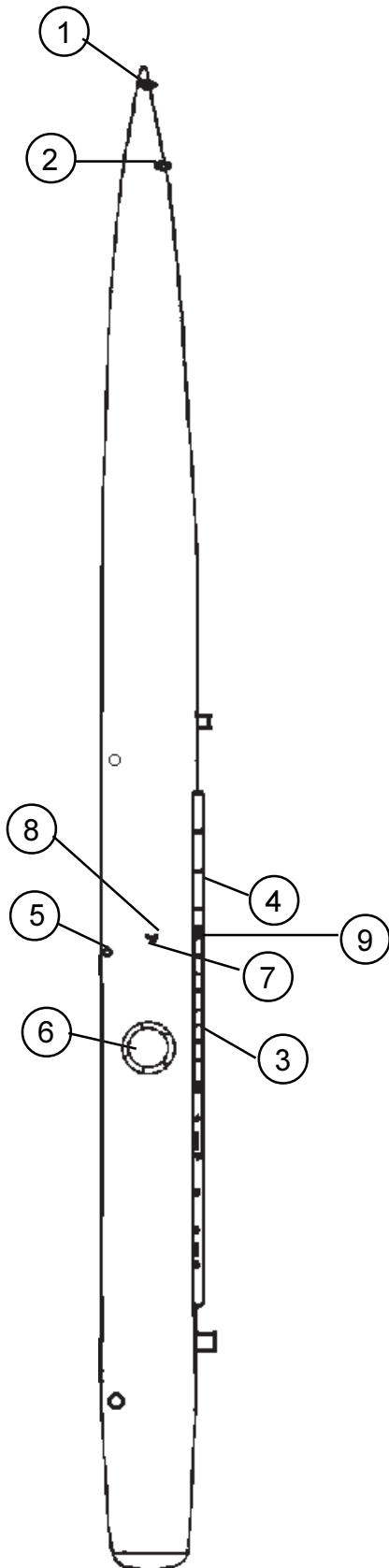

1 - 21060307 :	Platine de bride Bow tang Hahnepot Platte
2 - 99226002:	Vis Screw Schraube
3 - 21061630 :	Rail écoute de foc Jib track Fockschiene
4 - 21056041 :	Rail de trampolin Trampolin track Trampolinschiene
5 - 21056028 :	Vis cadène Anchor pin Schraube für Püttingeisen
6 - 99506070 :	Trappe de visite Inspection port Luckendeckel
7 - 17060410 :	Taquet coinreur dérive Jam cleat centerboard Schwertklampe
8 - 17060430 :	Poignée de dérive Centerboard handle Schwertfallgriff
9 - 21061640 :	Embout rail écoute de foc Jib track end cap Fockschiene-Endstück

HC 21 Coque/Hull/Rumpf

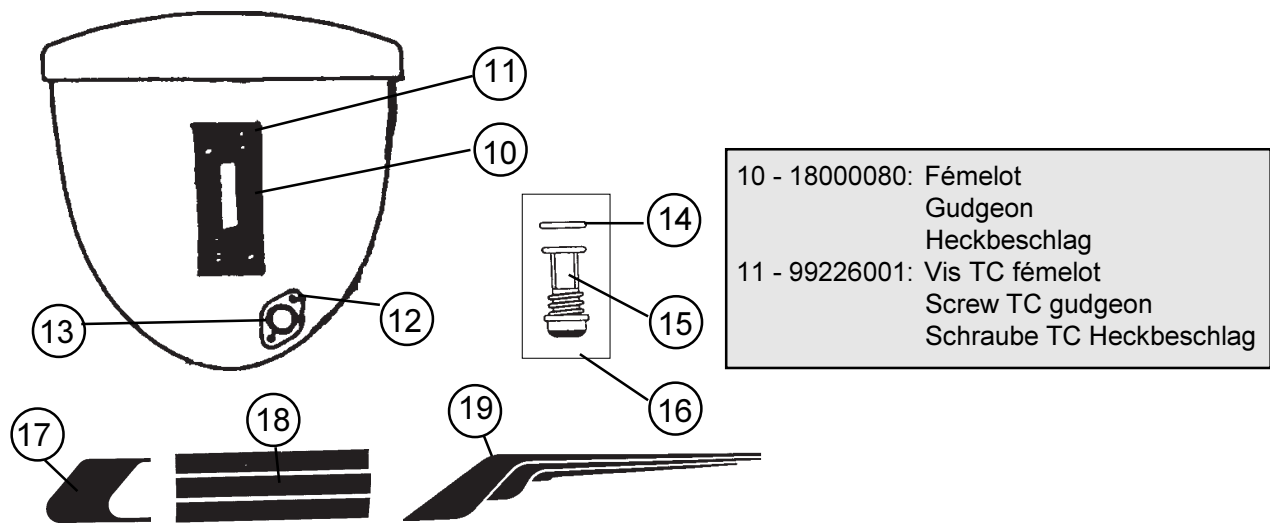

10 - 18000080: Fémelot
Gudgeon
Heckbeschlag
11 - 99226001: Vis TC fémelot
Screw TC gudgeon
Schraube TC Heckbeschlag

12 - 99220065: Vis TF Bouchon
Screw TF plug
Ablaßschraube TF
13- 99056012: Platine bouchon vidange
Drain housing
Platte f. Ablaßschraube
14- 99220041: Joint bouchon vidange
Drain gasket
Dichtung Ablaßschraube
15- 99220040: Bouchon vidange
Drain plug
Ablaßschraube
16- 99220043 : Joint + bouchon
(x10)
Gasket + drain plug
Dichtung + Ablaßschraube

17- Embout noir/Black stripe end cap/Endst.
Dekorstreifen.schwarz
99056051 : droit/right/rechts
99056099 : gauche/left/links
18- 17056081 : Bande Molokai coque
Molokai hull stripe
Klebeband Molokai f. Rumpf
19- Embout band Molokai/Molokai hull stripe end/
Endst. Molokaistreifen
17056083 : droit/right/rechts
17056082 : gauche/left/links

20- 21050920: Dérive pivotante
Centreboard
Klappschwert
21- 99220072: Vis TF
TF screw
Schraube
22- 21060310: Axe dérive
Centerboard pin
Schwertachse
23- 21056020: Ressort de dérive
Centerboard spring
Schwertfeder

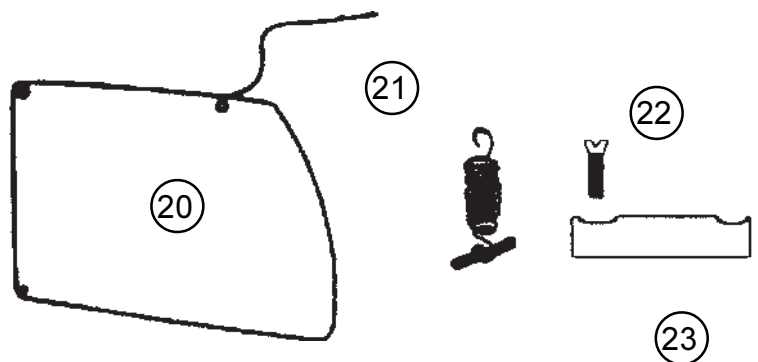

Gouvernail droit complet/Rudder assy right complet
 Ruderblatt komplett rechts :
 21062130 : White Knight

HC 21
Safran/Rudder/Ruderblatt

Gouvernail gauche complet/Rudder assy compl. left
 Ruderblatt komplett links :
 21062140 : White Knight

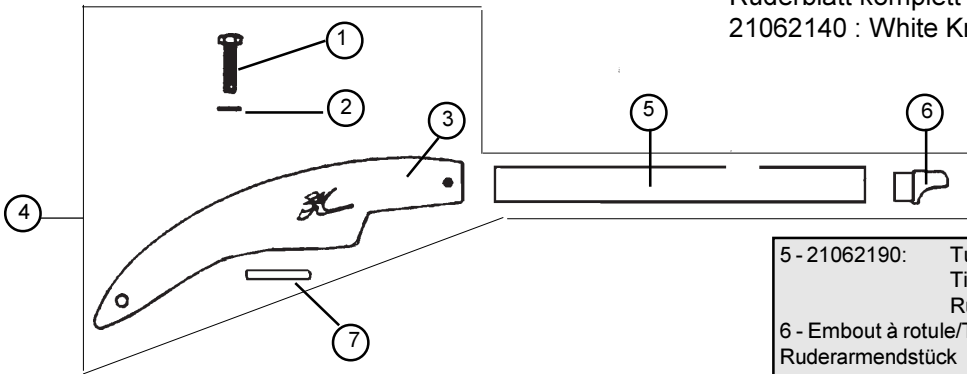

- 1 - 99221123: Vis TH 8x30 casting
Cast.bolt
Schraube Gußteil
- 2 - 99061110: Rondelle plate
Washer
Unterlegscheibe
- 3 - 17000010: Casting supérieur Gouv.
Upper rudder casting
Oberes Rudergehäuse
- 4 - 21062180: Bras gouv.droit complet
Tiller arm right complete
Ruderarm rechts komplett
- 21062185: Bras gouv.gauche complet
Tiller arm left complete
Ruderarm links komplett

- 5 - 21062190: Tube de Gouvernail
Tillertube
Ruderrohr
- 6 - Embout à rotule/Tiller end cap
Ruderarmendstück
99000005 : jusqu'à/till/bis Sept. 96
99061105 : depuis/as from/ab Sept. 96
- 7 - 14061122: Platine dural
Cam stop plate
Platine f. oberes Rudergehäuse
- 8 - 14061180: Came safran
Plastic cam
Rudernock
- 9 - 16041755: Goupille élastique
Maststep pin
Sprengbolzen
- 10- 99502175: Lame safran White Knight
Ruder blade
Ruderblatt
- 11- 99220003: Vis safran 8x60
99220066 (X50) Rudderbolt
Schraube Ruderblatt

Hobie Cat 21 Formula: Eclaté de pièces détachées / Illustrated part guide/Explosionszeichnung (1999/2000)

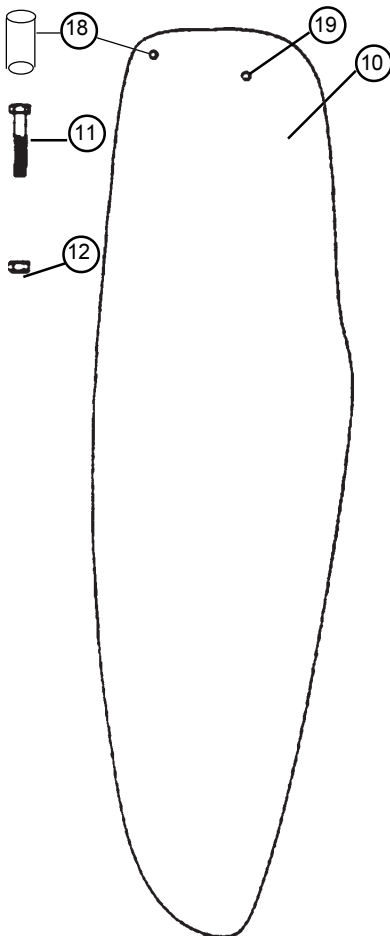

- 12- 99220012: Ecrou Nylstop
99220079 (x20) Nylstop nut
99220080 (x50) Selbstsichernde Mutter
13- 17000005: Casting inf. gouv
Lower rudder casting
Unteres Rudergehäuse
- 14- 21080340 (alu) Aiguillot + goupille
21080335 (inox) Rudder pin + cotter pin
Ruderbolzen + Splint
- 15- 14061105: Pene safran
Plunger
Gegenstück Rudernock
- 16- 99220004: Ressort inox
Spring
Feder
- 17- 99220006: Vis safran
Tension screw
Druckschraube
- 18- 99502130: Insert lame safran
Sheave pin rudder blade
Bolzen Ruderblatt
- 19- 14041711: Axe
Axe
Achse
- 20- 17062680: Casting inférieur monté
Lower rudder cast.assembled
Unteres Rudergehäuse montiert

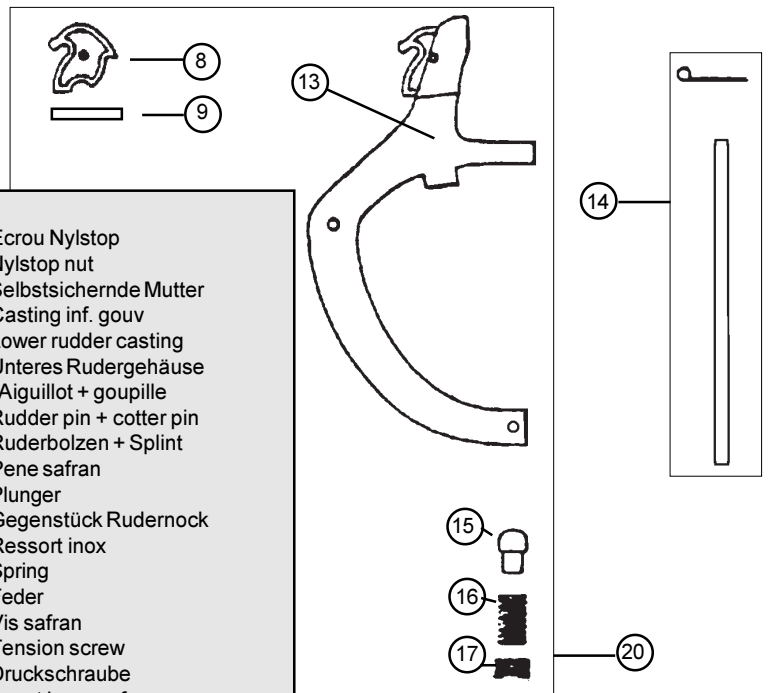

HC 21
 Etai et drisse cable de foc
 Forestay and jib halyard wire
 Vorstag und Fockfall

- 1 - 99220058 : Manille lyre 8 mm
Shackle 8 mm
Schäkel 8 mm
- 2 - 21080410 : Estrope + émerillon
Complete pigtail + swivel
Pigtail komplett
- 3 - 18060590 : Pivot étai de foc
Forestay swivel
Fockvorstagwirbel
- 4 - 18060540 : Poulie drisse de foc
Jib halyard block assembly
Fockfallumlenkblock
- 5 - 99220034 : Axe percé latte ridoir
99220081 (x50) Clevis pin
Bolzen für Locheisen gebohrt
- 6 - 99220031 : Anneau brisé
99220131 (x50) Split ring
99220230 (x10) Ringsplint
- 7 - 21060400 : Etai cable
18060521 (Fa) Forestay wire
Vorstagkabel

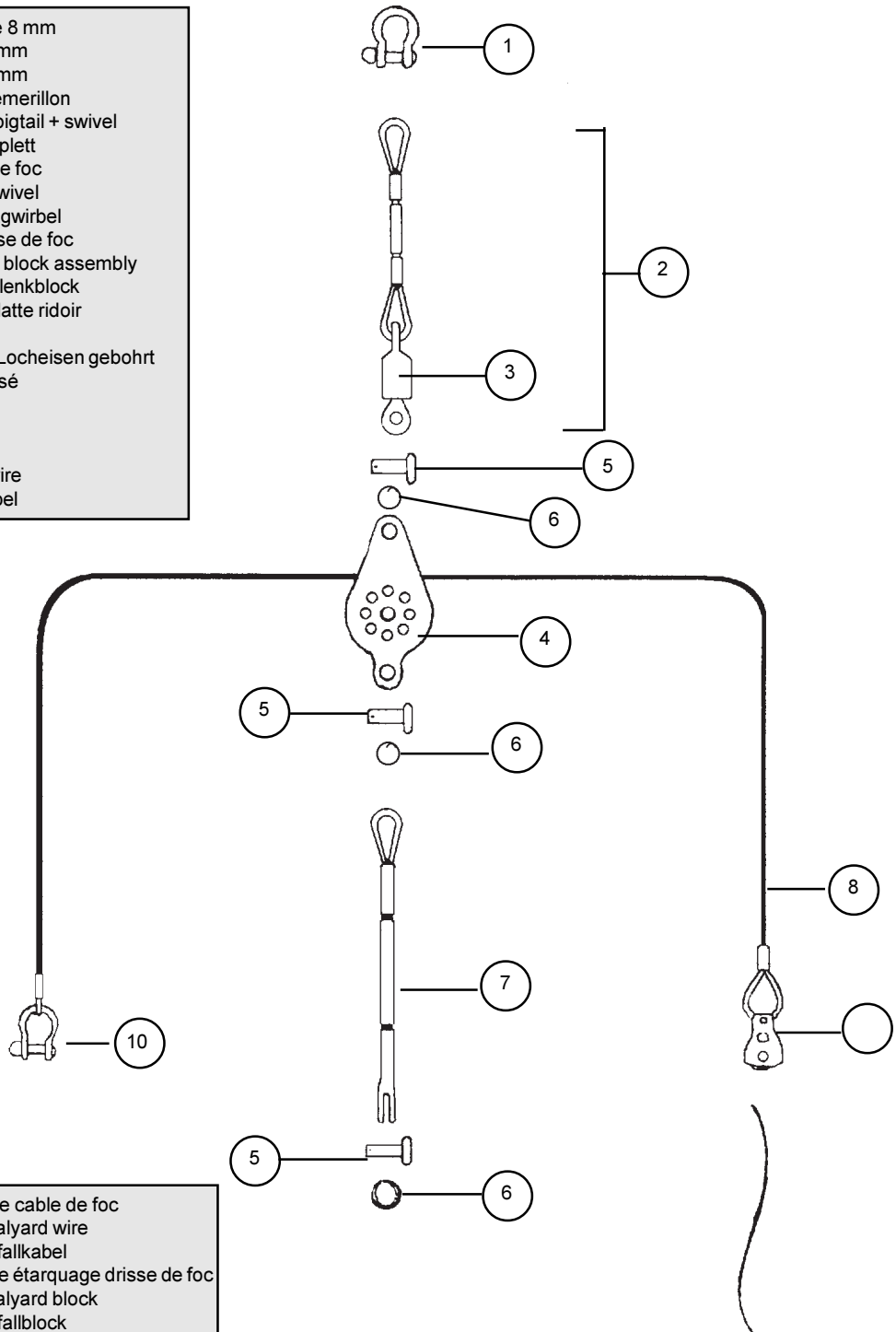

- 8 - 21060410 : Drisse cable de foc
Jib halyard wire
Fockfallkabel
- 9 - 18080100 : Poulie étarquage drisse de foc
Jib halyard block
Fockfallblock
- 10 - 99220036: Manille lyre 4 mm
99220097 (x50) Shackle 4 mm
Schäkel 4 mm



HC 21

Trapèze/Trapeze/Trapez

21060501 : Kit trapèze (2)
Trapeze Kit (2)
Trapezkit (2)

- | | |
|--------------------|--------------------|
| 1- 99220058: | Manille Lyre |
| 99220210 (x10) | Bow shackle |
| | Mastschäkel |
| 2- 99300053: | Cosse |
| | Thimble |
| | Kausch |
| 3- 99300054: | Manchon |
| | Sleeve |
| | Hülse |
| 4- 21060470: | Cable trapeze |
| | Trapeze wire |
| | Trapezkabel |
| 5- 16080552: | Poignée Trapèze |
| | Trapeze handle |
| | Trapezgriff |
| 6- 18060420: | Cordage de réglage |
| | Trapeze line |
| | Trapezleine |
| 7- 99500040 (x2) : | Poignée J&H |
| 99500032 (x20) | Handle J&H |
| | Griff J&H |
| 8- 18060301: | Double anneau |
| 18060312 (x20) | Rope lock |
| 18060313 (x40) | Trapezstopper |
| 9- 21080555: | Sandow trapèze |
| | Trapeze shock cord |
| | Gummistrop Trapez |

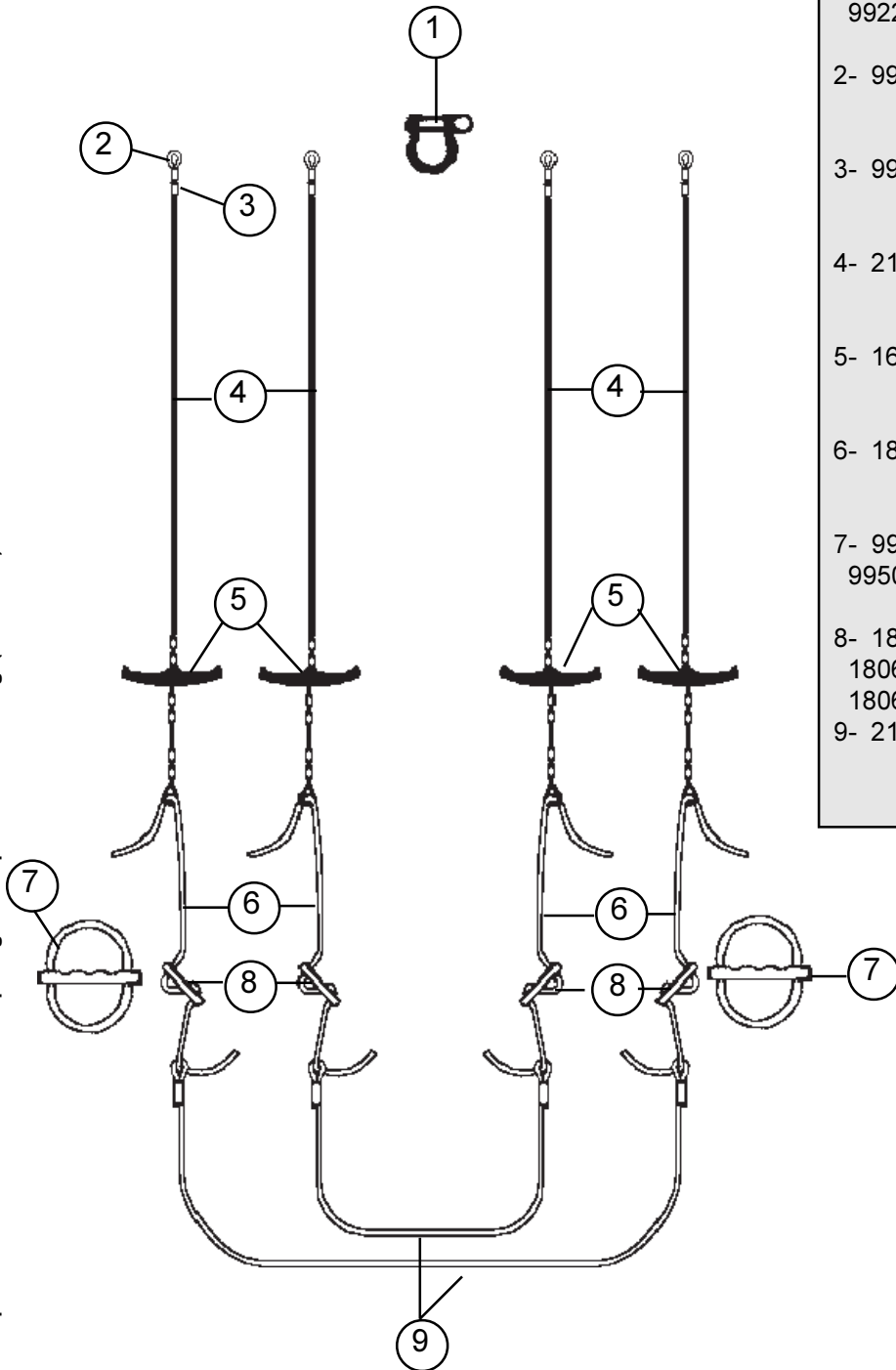

HC 21
Haubans/Shrouds/Wanten
21080400

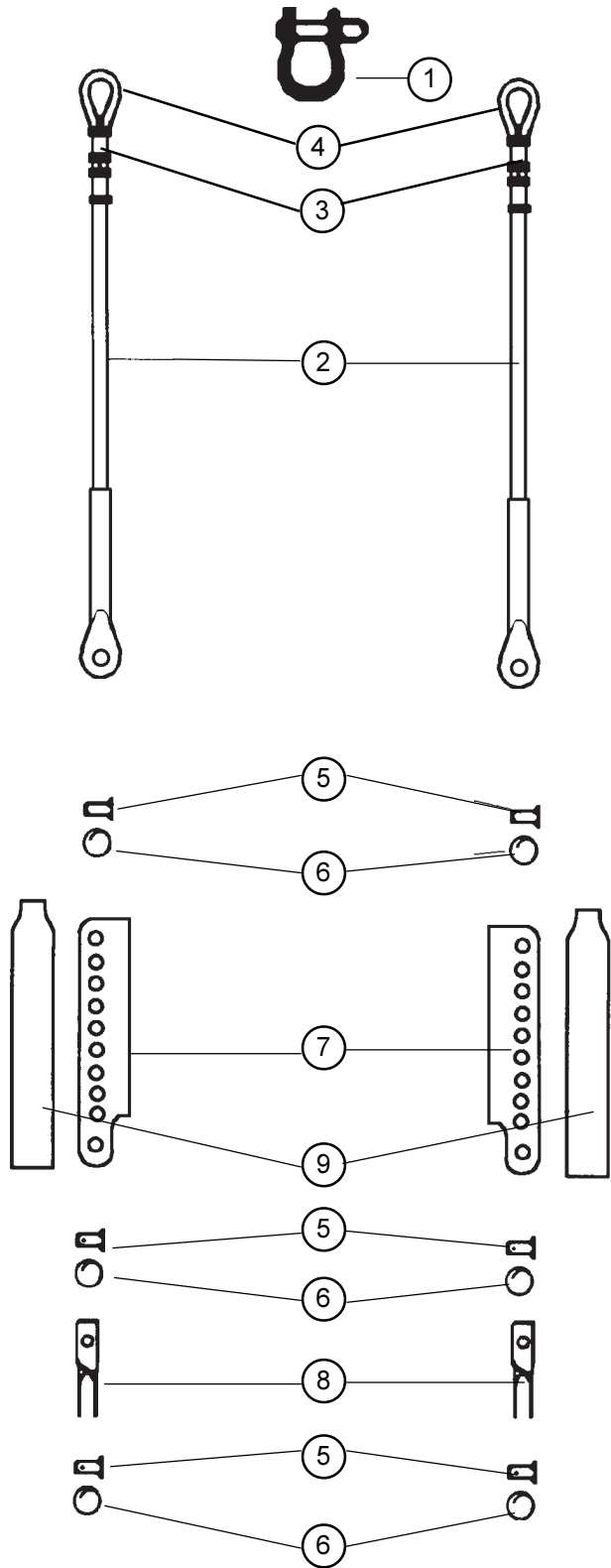

1-	99220058: 99220210 (x10)	Manille Lyre 8 mm Bow shackle Mastschäkel
2-	21080400:	Hauban Shroud Want
3-	99300051:	Manchon Sleeve Hülse
4-	99300053:	Cosse std Thimble Kausch Std
5-	99220034: 99220081 (x50)	Axe percé lat.ridoir Clevis pin Bolzen für Locheisen
6-	99220031: 99220131 (x50) 99220230 (x10)	Anneau brisé Split ring Ringsplint
7-	21060563:	Latte ridoire Stay adjuster Wanteisen
8-	21056015:	Chape de hauban Toggle Wanten Toggle
9-	99500360: 99500363 (x2) 99500364 (x20)	Protège latte ridoire Shroud adjuster cover Wantenschutz

HC 21
Brides/Bridles/Hahnepot

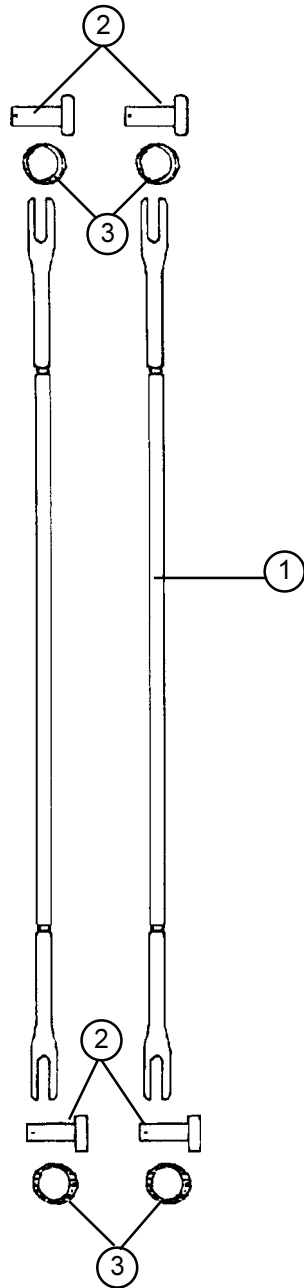

- 1 - 21060440 : Bride (18 & 18 Fa)
Bridle
Hahnepot
- 2 - 99220034 : Axe percé latte ridoire
99220081 (x50) Clevis pin
Bolzen für Locheisen gebohrt
- 3 - 99220031 : Anneau brisé
99220131 (x50) Split ring
99220230 (x10) Ringsplint

HC 21
Traverse avant/Front crossbar
Vorderholm
21062560

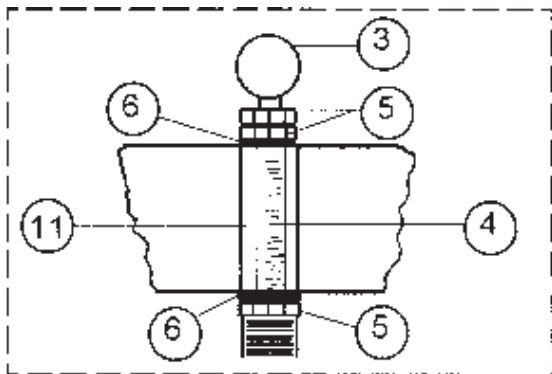

1 - 21062540 :	Traverse AV nue Bare front crossbar Vorderholm roh
2 - 21062620 :	Martingale Striker rod Unterzug
3 - 21062673 :	Emplanture de mât Mast step Mastfußpfanne
4 - 99219000 :	Tige filetée Threaded shank Gewindeachse

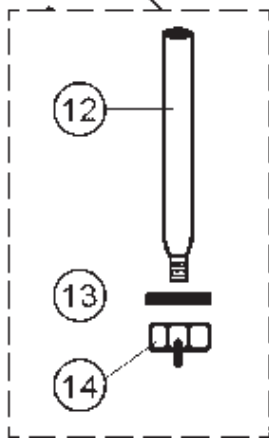
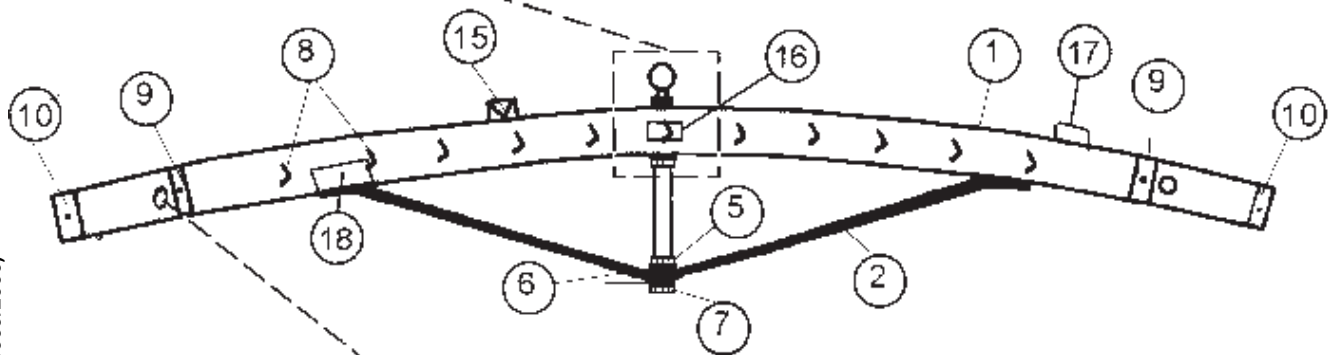

5 - 99220104 :	Ecrou HU D16 Nut HU D16 Mutter HU D16
6 - 99220100 :	Rondelle D16 Washer D16 Unterlegscheibe D16
7 - 99220110 :	Ecrou indessérable Nylstop nut Selbstsichernde Mutter
8 - 99220105 :	Pontet Eyestraps Bügel
9 - 21062502 :	Pallier intérieur In board bearing Innenlager Beam
10 - 21062506 :	Pallier extérieur Out board bearing Außenlager
11 - 99100110 :	Renfort alu martingale Compression sleeve Alu Verstärkung für Unterzug
12 - 21060300 :	Axe fixation traverse Taper pin Holmbefestigung-Schraube
13 - 99220026 :	Rondelle D12 Washer D12 Unterlegscheibe D12
14 - 21060302 :	Ecrou + anneau trav. avant Front crossbar nut + ring Vorderholm-Mutter + Ringe

15 - 99220063 :	Taquet renvoi de foc Jib cleat + screw Fockumlenk-Klemme
16 - 18056024 :	Articulation tangon Pole connector Spibaumverbindung
17 - 99220130 :	Taquet drisse de spi Spi cleat Spiklemme
18 - 21062651 :	Casting renfort martingale Striker bar reinforcement Verstärkung Unterzug

Hobie Cat 21 Formula: Eclaté de pièces détachées / Illustrated part guide/Explosionszeichnung (1999/2000)

HC 21
Traverse arrière/Rear crossbar
Achterholm
21062550

- 1 - 21062530: Traverse arrière nue
Bare rear crossbar
Achterholm roh
- 2 - 21056041 : Rail de trampolin
Trampoline track
Trampolinschiene
- 3 - 21062520 : Rail d'écoute grand-voile
Traveller track main sail
Travellerschiene Großsegel
- 4 - 21062521 : Embout rail d'écoute grand-voile
Traveller track end stop
Travellerschiene Endstück
- 5 - 14070325 : Pontet point d'amure
Eyestraps ratchet block
Bügel für Knarrblock

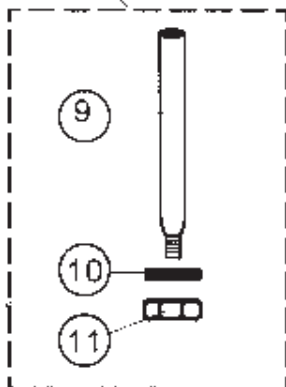
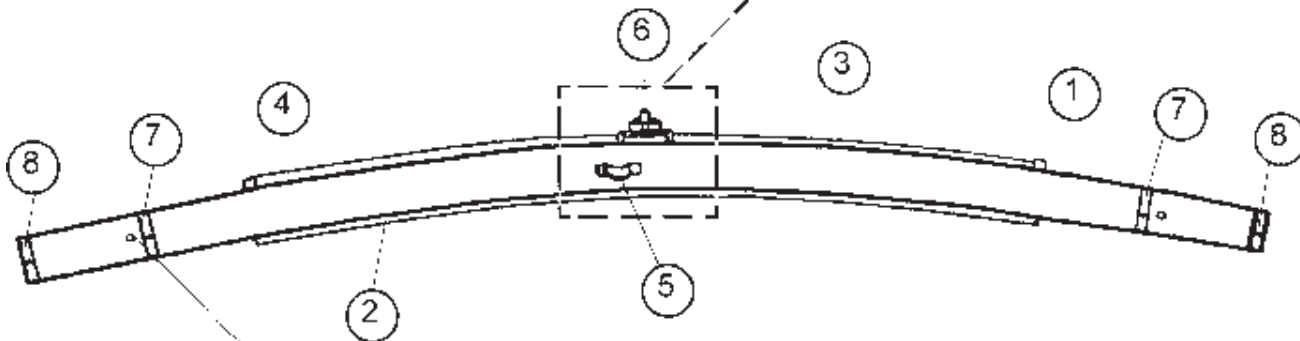
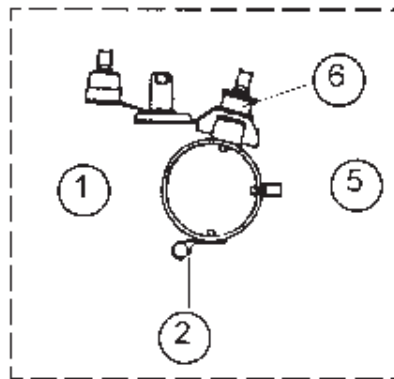

- 6 - 21060050 : Chariot de grand-voile + Tourelle
Traveller car + rotation cleat
Großtraveller mit Drehklemme
- 7 - 21062502 : Pallier intérieur
In board bearing
Innenlager Beam
- 8 - 21062506 : Pallier extérieur
Out board bearing
Außenlager
- 9 - 21060300 : Axe fixation traverse
Taper pin
Holmbefestigungsschraube
- 10- 99220026 : Rondelle D12
Washer D12
Unterlegscheibe D12
- 11- 99220028 : Ecrou indessérable D12
Nylstop nut D12
Selbstsichernde Mutter D12



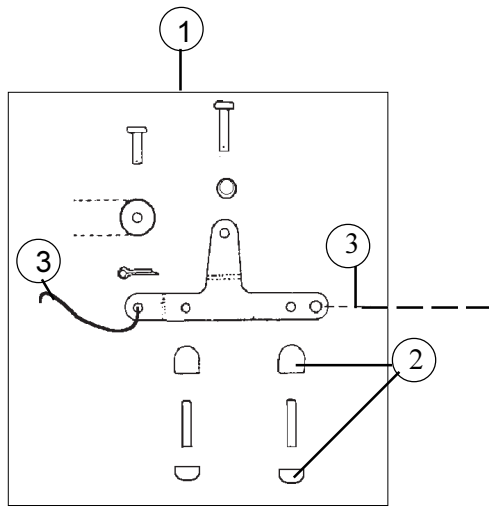

HC 21
Bôme/Boom/Baum
21012855

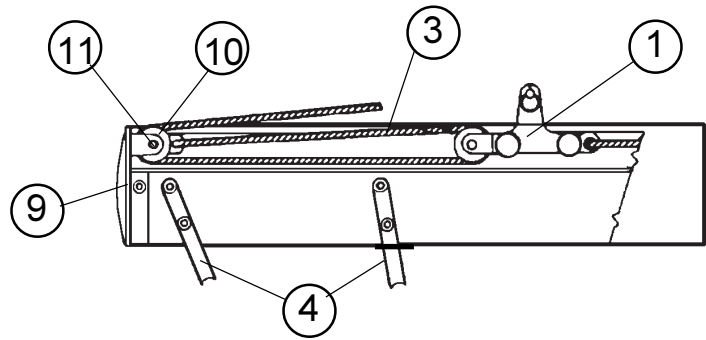

- 1 - 18011810: Chariot de bôme
Outhall car assembly
Baumtraveller Blech
- 2 - 18011840: Demi-bille
Half ball
Halbkugel
- 3 - 21041790: Kit cordage bôme
Boom rope kit
Leinensatz für Baum
- 4 - 14011830: Collier de bôme
Block hanger
Baumbeschlag

- 5 - 18012803: Manchon taquet de bôme
Clamp assembly
Klemme für Unterliekstrecker
- 6 - 99500351: Taquet de bôme alu
Boom clamp cleat alu
Baumklemme Alu
- 7 - 99222802: Vis de manchon
Screw
Hülse Schraube
- 8 - 18000010: Embout avant de bôme percé
Drilled front boom end cap
Baumendkappe vorne gebohrt

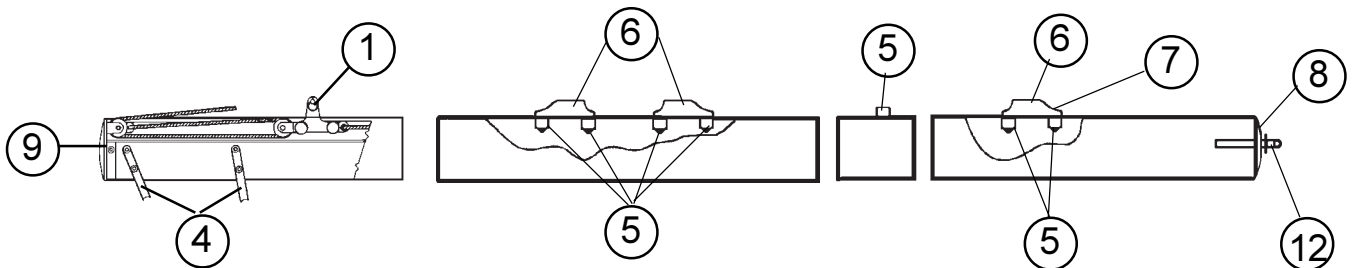

- 9 - 18000005: Embout arrière de bôme
Boom rear end cap
Baumendkappe hinten
- 10- 18041765: Réa tête de mât
Mast head sheave
Mastkopf Rolle
- 11- 18220830: Axe réa bôme
Boom sheave pin
Baum Achse
- 12- 14011820: Ancrage vit mulet
Gooseneck fastening
Verankerung für Lümmelbeschlag



Jusqu'à/till/bis Sept 1996

HC 21 Formula
 Barre d'accouplement & stick
 Tiller crossbar & stick
 Anlenkstange & Pinne

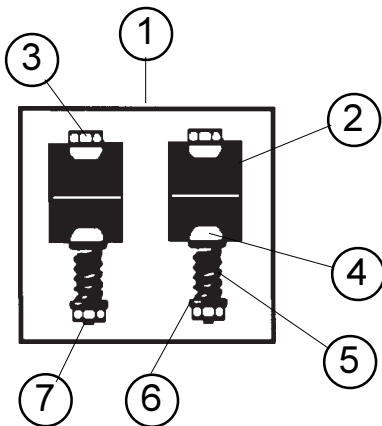

- 1 - 99500380: Kit d'articulation TCM LE
Tiller connector kit LE
Verbindungsgelenk LE
- 2 - 99500331: Demi-pallier
Rubber spacer
Distanzhülse
- 3 - 99220027: Vis TH
TH screw
TH Schraube
- 4 - 99220029: Demi-bille nylon
Half ball nylon
Nylon Halbkugel
- 5 - 99500335: Ressort TCM
TCM spring
TCM Feder

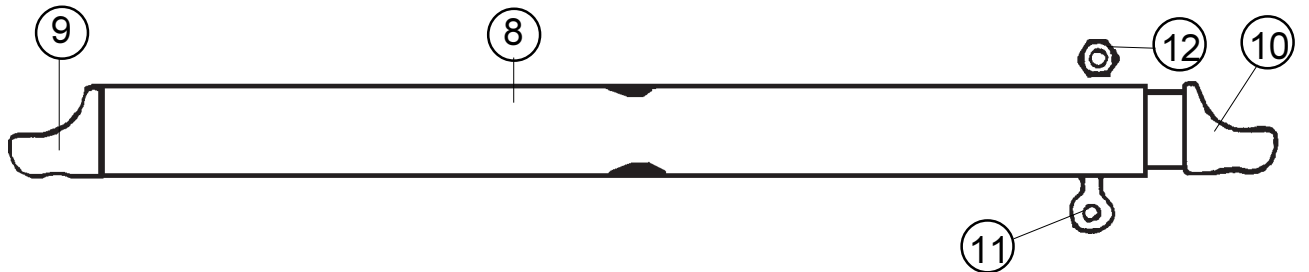

- 6 - 99220032: Rondelle inox
Stainless washer
Unterlegscheibe
- 7 - 99220019: Ecrou indessérable D6
Nylstop nut D6
Selbstsichernde Mutter D6
- 8 - 21062250 : Barre accoupl. complète
Complete tiller crossbar
Anlenkstange komplett
- 9 - 99000005: Embout à rotule
Tiller end cap
Pinnenendstück

- 10- 99000010 : Coulisseau réglable
Adjustable tiller end
Gleiter
- 11- 99220010 : Vis manillon
Shackle bolt
Schraube für Schäkel Anlenkst.
- 12- 99220011 : Ecrou HU D8
99220073 (x20)
Nut HU D8
Mutter HU D8
- 13 - 99501310: Kit d'articulation stick
Tiller connector kit extension
Pinnenausleger-Verbindung

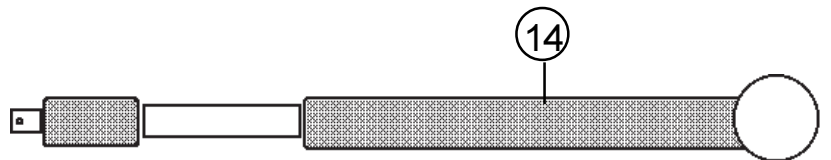
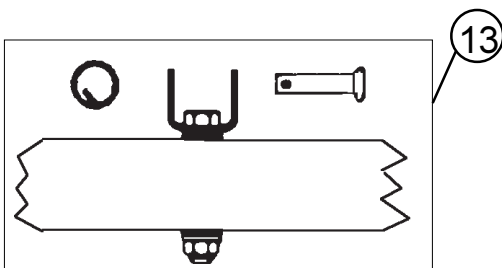

- 14 - 99502310: Stick télescopique
Telescopic tiller extension
Teleskop Pinnenausleger

Hobie Cat 21 Formula: Eclaté de pièces détachées / Illustrated part guide/Explosionszeichnung (1999/2000)

NOUVEAU/NEW/NEU

HC 21 Formula
 Barre d'accouplement & stick
 Tiller crossbar & stick
 Anlenkstange & Pinne

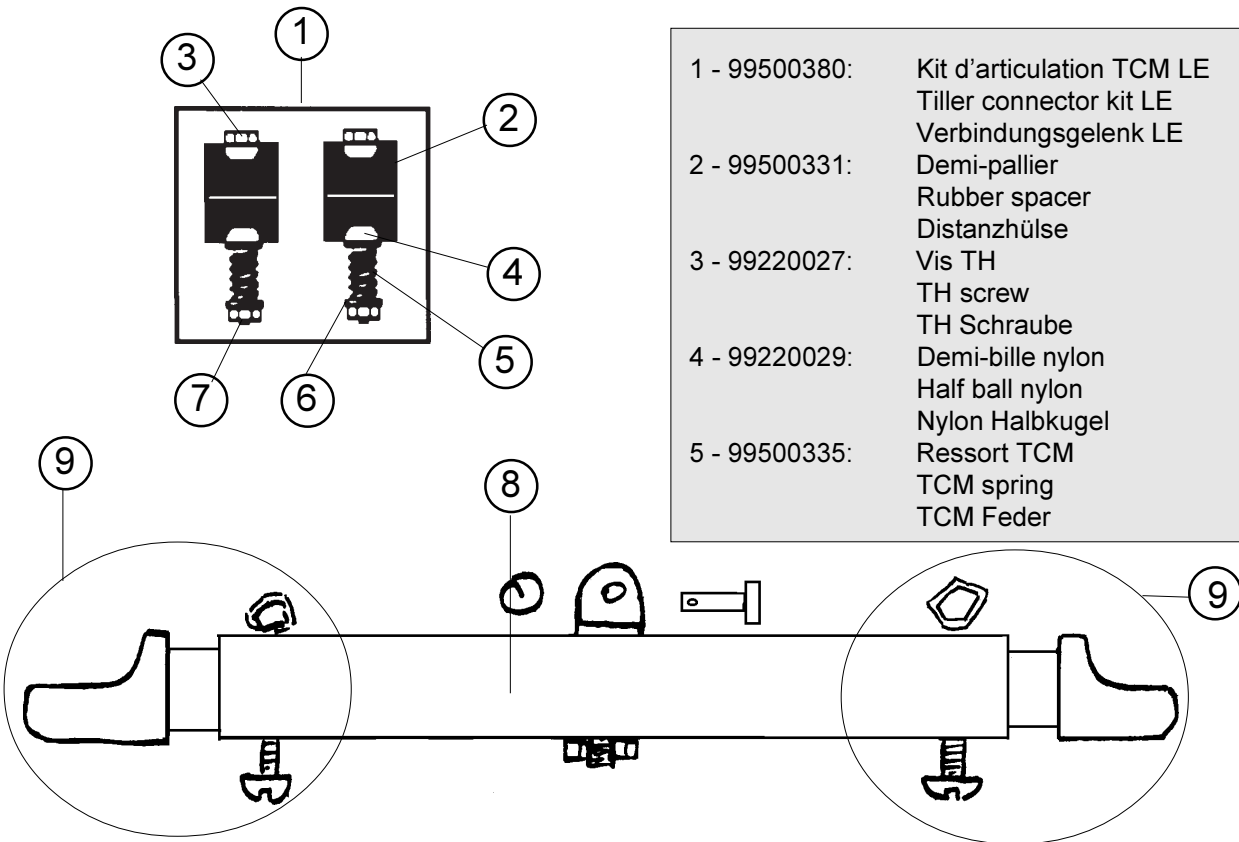

- 1 - 99500380: Kit d'articulation TCM LE
Tiller connector kit LE
Verbindungsgelenk LE
- 2 - 99500331: Demi-pallier
Rubber spacer
Distanzhülse
- 3 - 99220027: Vis TH
TH screw
TH Schraube
- 4 - 99220029: Demi-bille nylon
Half ball nylon
Nylon Halbkugel
- 5 - 99500335: Ressort TCM
TCM spring
TCM Feder

- 6 - 99220032: Rondelle inox
Stainless washer
Unterlegscheibe
- 7 - 99220019: Ecrou indessérable D6
Nylstop nut D6
Selbstsichernde Mutter D6
- 8 - 21062270 : Barre accoupl. complète
Complete tiller crossbar
Anlenkstange komplett

- 9 - 99061703: Kit coulisseau
Adjustable tiller end kit
Gleiter kit
- 10 - 99501310: Kit d'articulation stick
Tiller connector kit extension
Pinnenausleger-Verbindung
- 11 - 99502310: Stick télescopique
Telescopic tiller extension
Teleskop Pinnenausleger

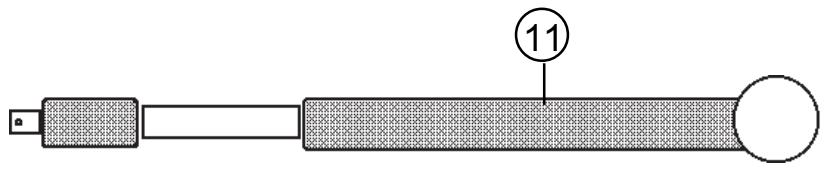
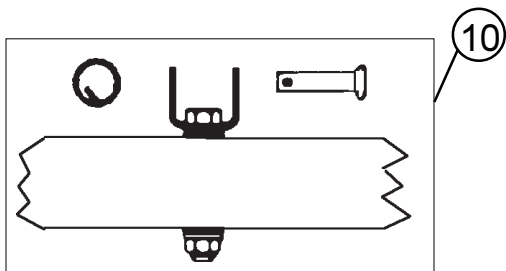

Hobie Cat 21 Formula: Eclaté de pièces détachées / Illustrated part guide/Explosionszeichnung (1999/2000)

HC 21 Enrouleur Jib furling assembly Fockroller - 21060150

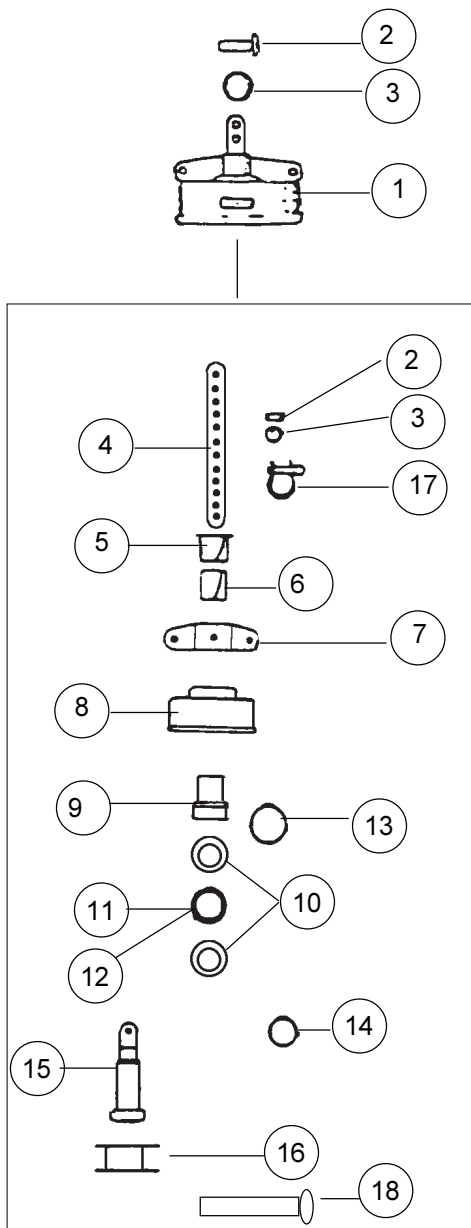

18 - 21062160 : Vis de blocage
Locking screw
Blockierungsschraube

- | | |
|---|--|
| 1 - 21060150 : | Enrouleur
Jib furling assembly
Fockroller |
| 2 - 99220034 :
99220081 (x50) | Axe percé latte ridoir
Clevis pin
Bolzen für Locheisen |
| 3 - 99220031 :
99220131 (x50)
99220230 (x10) | Anneau brisé
Split ring
Ringsplint |
| 4 - 99220350 : | Latte ridoire enrouleur
Furling stay adjuster
Fockroller-Stagspanner |
| 5 - 21060151 : | Entretoise nylon supérieure
Upper nylon bushing
Obere Nylon Hülse |
| 6 - 21060152 : | Entretoise nylon inférieure
Lower nylon bushing
Untere Nylon Hülse |
| 7 - 21060590 : | Coupleur à brides
Yoke
Hahnepotverkappung |
| 8 - 21060153 : | Carter plastic
Housing see pool
Plastikgehäuse |
| 9 - 21060157 : | Entretoise métal
Sleeve
Metallhülse |
| 10 - 21060158 : | Flasque roulement
Bearing race
Kugellagerseitenwand |
| 11 - 21060154 : | Cage de roulement
Bearing cage
Kugellager Gehäuse |
| 12 - 21060156 : | Bille de roulement
Bearings
Kugellager |
| 13 - 21060305 : | Circlips grand modèle
Darby ring large
Offener Ring groß |
| 14 - 21060306 : | Circlips petit modèle
Darby ring small
Offener Ring klein |
| 15 - 21060313 : | Axe principal
Tube
Hauptachse |
| 16 - 21060155 : | Bobine
Spool
Trommel Fockroller |
| 17 - 99220035 :
99220092 (x20)
99220093 (x50) | Manille 6 mm
Shackle 6 mm
Schäkel 6 mm |

HC 21
Barre de flèche et cables
Spreaders and diamond wires
Saling und Diamondwant

21060460 : KIT BARRE DE FLECHE
 SPREADER ASSEMBLY
 SALING KIT

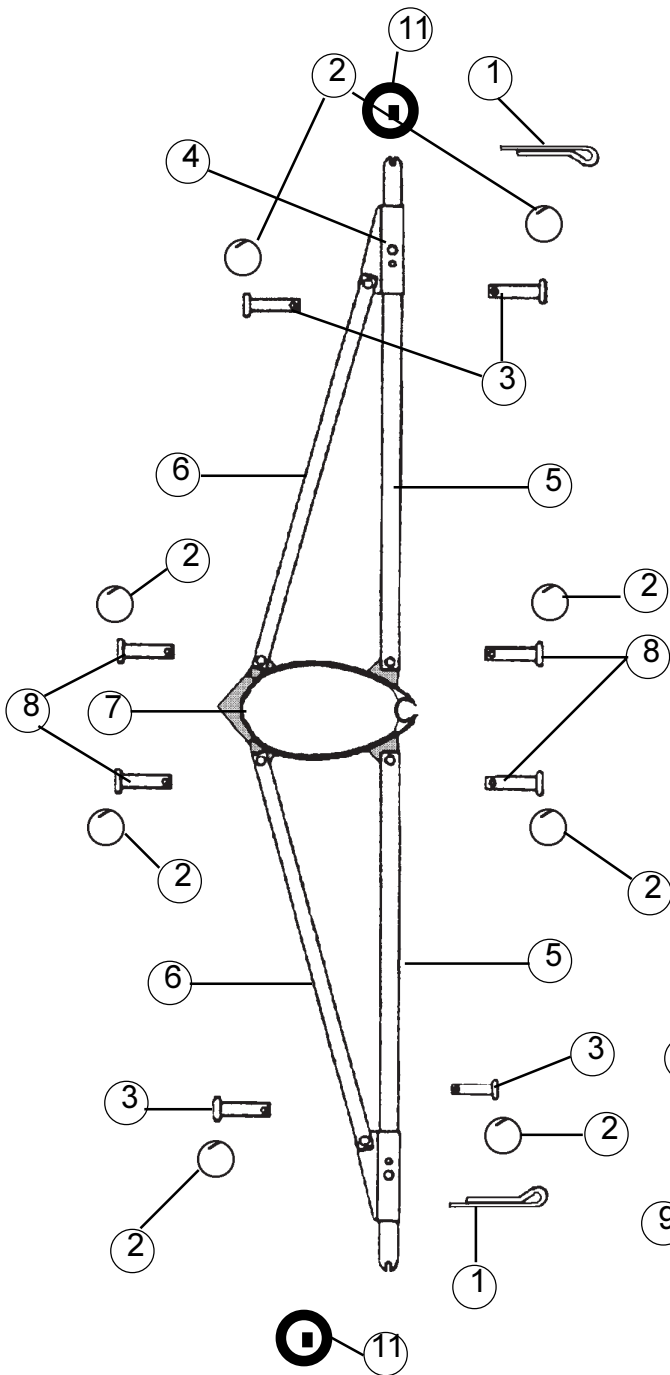

- 1 - 99220037: Goupille 2,5x20 aiguillot
rudder pin slit cotter pin
Gespal. Stift 2,5x20 Ruderbolzen
- 2 - 99220031: Anneau brisé
99220131 (x50) Split ring
99220230 (x10) Ringsplint
- 3 - 18060315: Axe de flèche long
Spreader long pin
Salingachse lang
- 4 - 18060309: Collier barre de flèche
Spreader arm adjuster
Salingarm Flansch
- 5 - 21060304: Barre de flèche
Spreader arm
Saling
- 6 - 21060308: Support de flèche
Spreader brace
Salingstütze
- 7 - 21060301: Collier support de flèche
Spreader slide adjuster
Saling Ringflansch
- 8 - 99220047: Axe percé vit mulet
Clevis pin
Lümmelbeschlag Bolzen

- 9 - 99220034: Axe percé latte ridoire
Clevis pin
Bolzen f. Locheisen
- 10 - 21060420: Cable de flèche
Diamond wire
Diamondwant
- 11 - 18034111: Kit protège foc Tren,tec
Jib protection kit Trentec
Kit Fockschutz Trentec
- 12 - 18060563: Protège foc roue
Protection jib wheel
Fockschutzrolle
- 13 - 21060562: Latte ridoire à vis
Stay adjuster with screw
Locheisen verschraubt

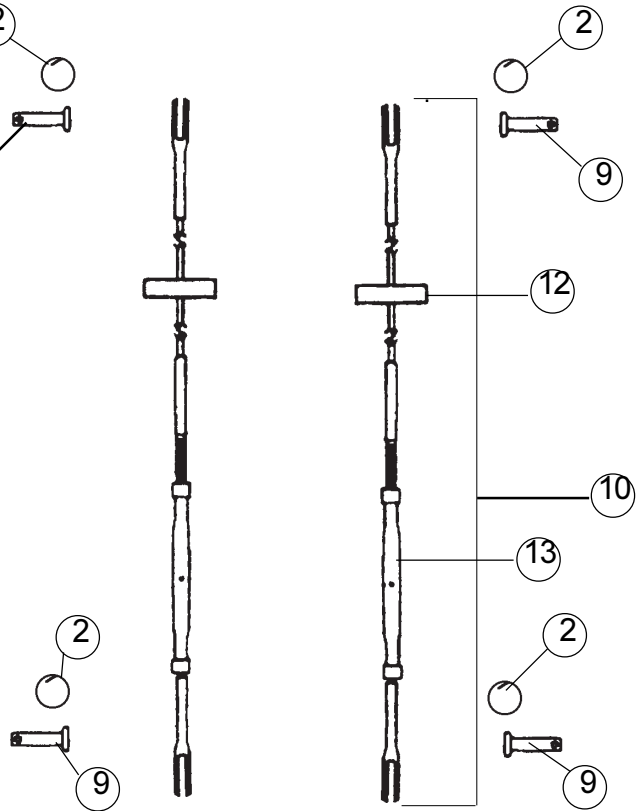

21042750 : Mât complet ss tourelle
 Complete mast w/o block
 Mast komplett o. Vorliekstrecker

HC 21
 Mât/Mast/Mast

- 1 - 18000030 : Tête de mât
Mast head
Masttop
- 2 - 21041750 : Hook de drisse
Halyard hook
Fallhaken
- 3 - 21041721 : Ferrure de capelage de spi
Mast tang spi
Mastbeschlag Spi
- 4 - 99220057 : Pontet forgé
Eyestrapp
Bügel
- 5 - 99500114 : Poulie 082 H
Harken block 082
Harkenblock 082
- 6 - 18042712 : Anneau de drisse + manille
Ring shackle assembly
Großfall Ring + Schäkel
- 7 - 21041720 : Ferrure de capelage
Mast tang
Mastbeschlag
- 8 - 21080511 : Barrette cable de flèche
Diamond wire holder
Salingendstück
- 9 - 21060301 : Collier support de flèche
Spreader slick adjuster
Saling Ringflansch
- 10 - 18062717 : Plaque de compression
Compression sleeve plate
Verstärkungsplatte

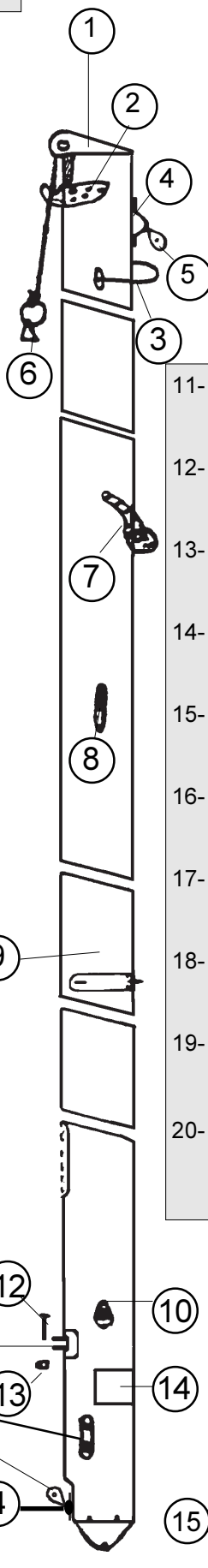

- 11- 18011860 : Embase de vit mulet
Gooseneck base
Lümmelbeschlag Untersatz
- 12- 99220311 : Vis TH
TH Screw
Schraube TH
- 13- 99220019 : Ecrou nylstop 6
Nylstop nut 6
Selbstsichernde Mutter 6
- 14- 14041723 : Autocollant de sécurité
Mast caution label
Sicherheitsaufkleber
- 15- 21041752 : Base de mât
Mast base
Mastfußpfanne
- 16- 17060302 : Bras de rotation de mât
Rotation arm
Rotationsarm
- 17- 16056022 : Ferrure d'étai
Bow tang
Bugbeschlag
- 18- 99220307 : Vis TH
TH Screw
Schraube TH
- 19- 99080530 : Tourelles cunningham
Dowhaul swivel jam block
Drehklemme Vorliekstr.
- 20- 99220225 : Platine tourelle
Rotation cleat mounting
Drehklemme Untersatz

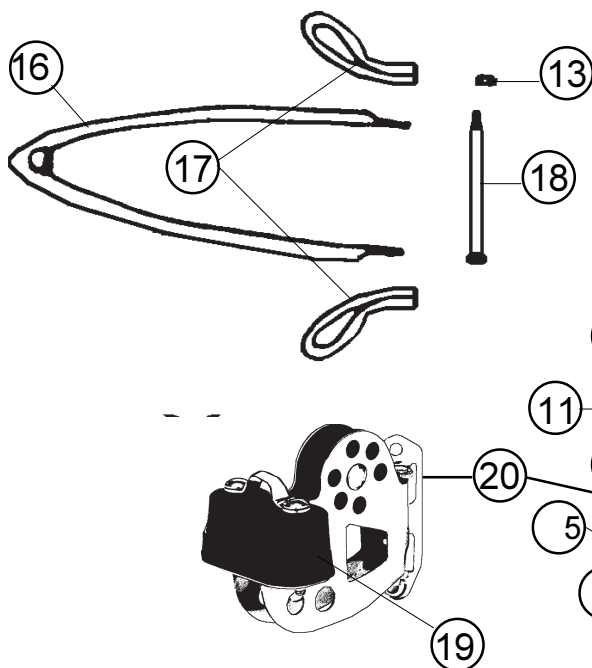

Hobie Cat 21 Formula: Eclaté de pièces détachées / Illustrated part guide/Explosionszeichnung (1999/2000)



HC 21
Grand-voile/Main sail/Großsegel

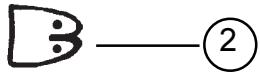

Grand-voile/Main Sail/Groß-Segel :
Pour les couleurs : voir tarif
For colors : see price list
Farben : siehe Preisliste

- | | |
|----------------|--|
| 1 - 99500072 : | Flamme de voile
Telltail
Telltail |
| 2 - 99500325 : | Embout de latte
Batten end cap
Lattenendstück |
| 3 - 99267286 : | Autocollant "H" noir
"H" black sticker
Aufkleber "H" schwarz |
| 4- 21034015 : | Jeu de lattes GV complet
Batten set MS complete
Lattensatz GS komplett |

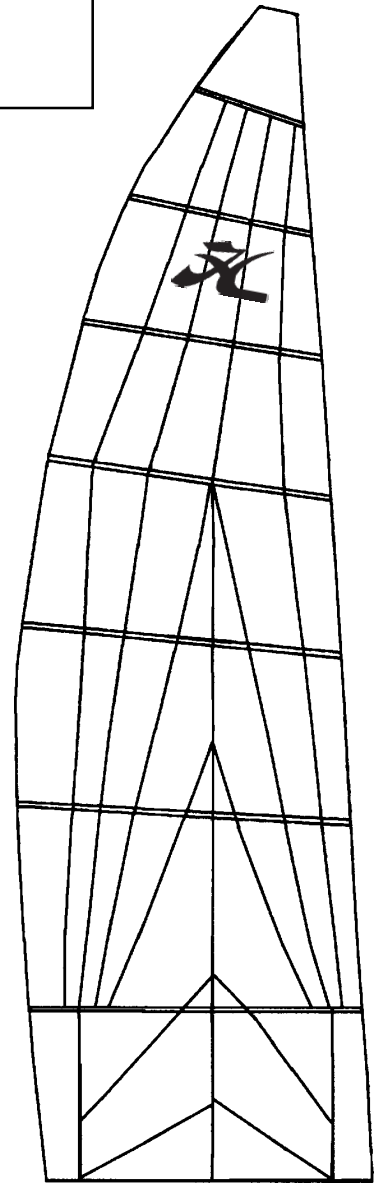

④

- | | | |
|----------|--|---|
| 21034007 | | 7 |
| 21034006 | | 6 |
| 21034005 | | 5 |
| 21034004 | | 4 |
| 21034003 | | 3 |
| 21034002 | | 2 |
| 21034001 | | 1 |

HC 21
Foc/Jib/Fock

Pour les couleurs : voir tarif
For colors : see price list
Farben : siehe Preisliste

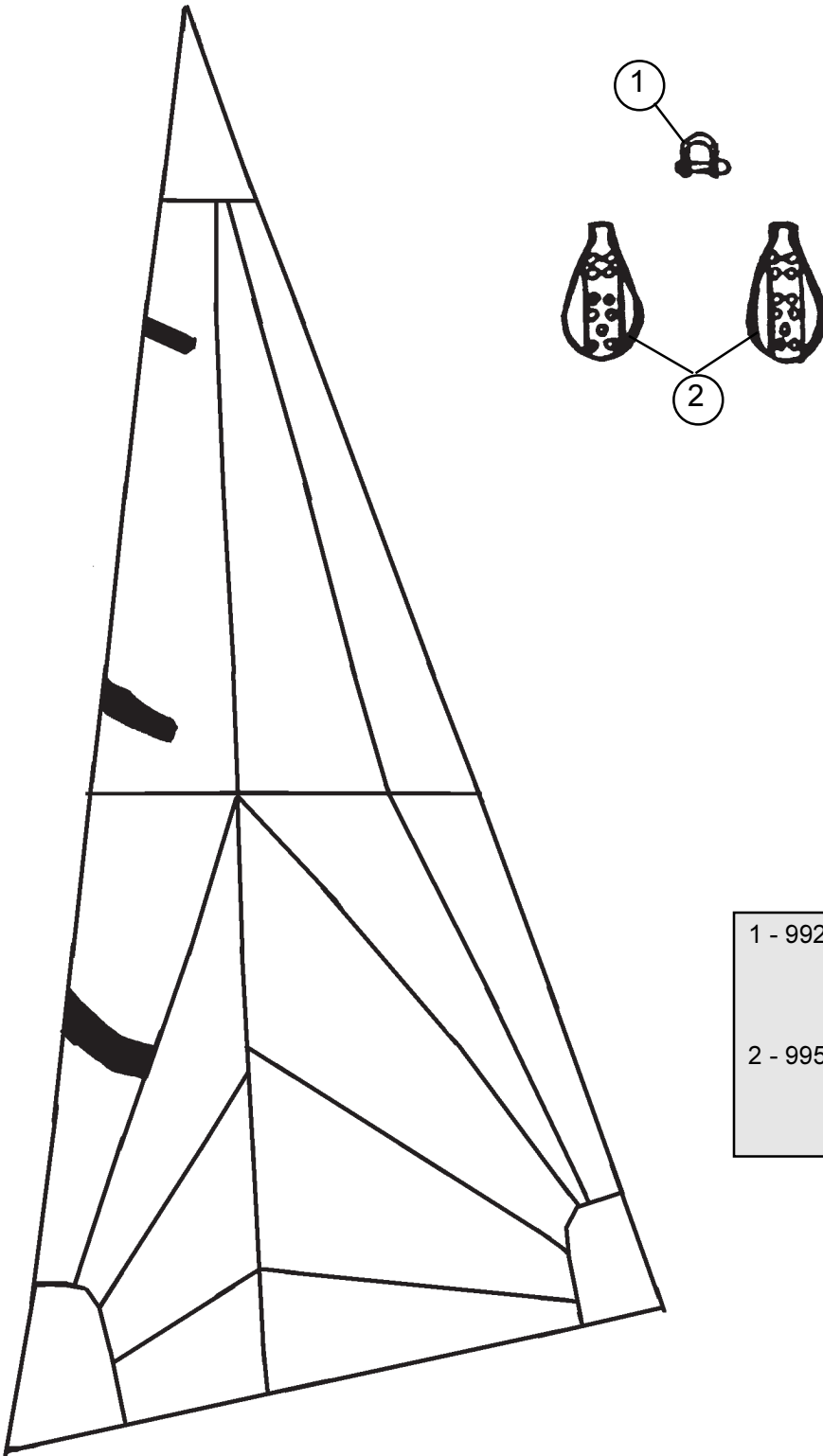

- | | |
|----------------|---|
| 1 - 99220035 : | Manille lyre 6 mm
Shackle 6 mm
Schäkel 6 mm |
| 2 - 99500118 : | Poulie Harken
Harken block
Harkenblock |

HC 21 Formula
Trampolin/Trampoline/Trampolin

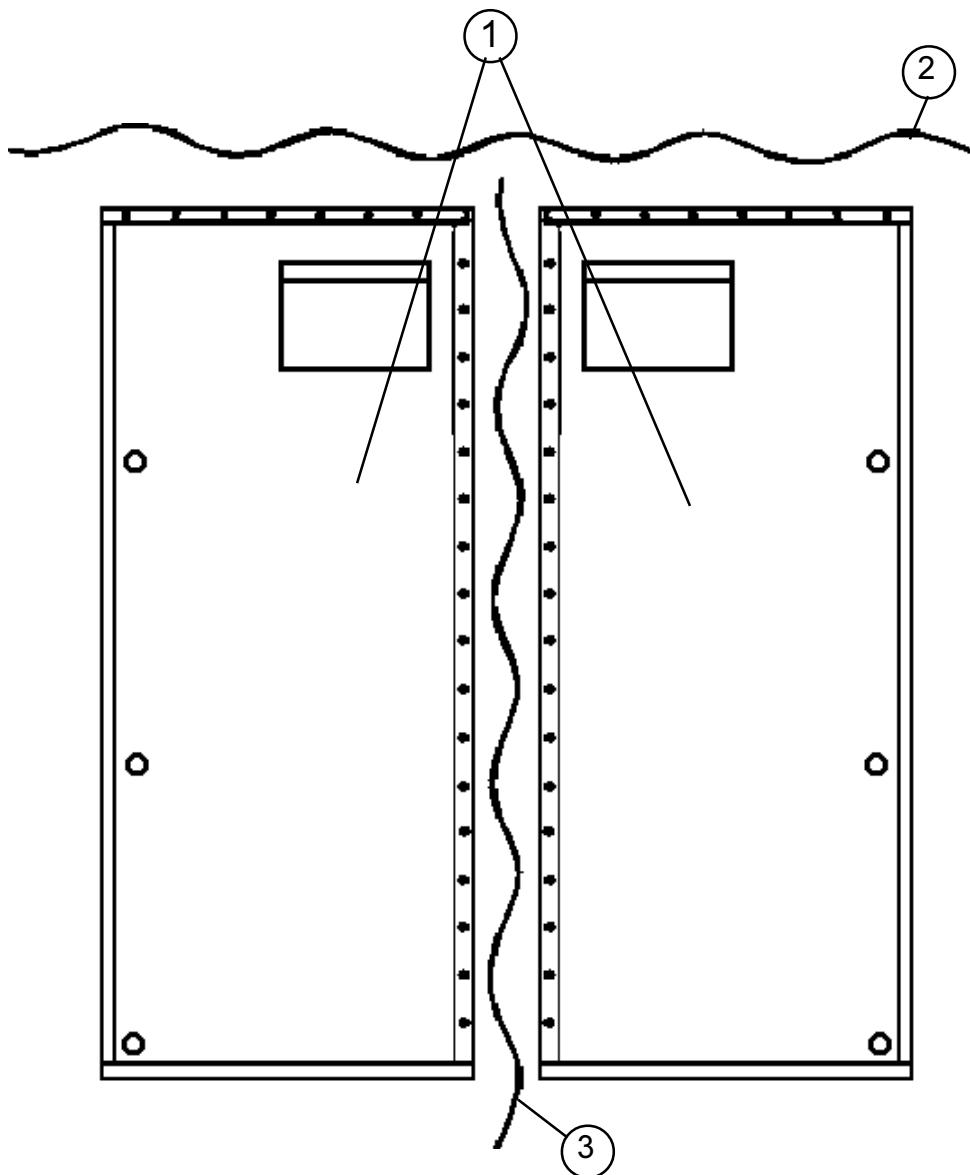

- | | |
|--|-------------------------|
| 1 - Trampolin 2 pièces/2 piece trampoline/Trampolin 2-teilig | |
| 21025800 : | Mesh/Netz |
| 2 - 16070430 : | Lacet arrière |
| | Rear line |
| | Trampolinleine hinten |
| 3 - 16070440 : | Lacet central |
| | Central trampoline line |
| | Trampolinleine mitte |

HC 21
Ailes/Wings/Wing

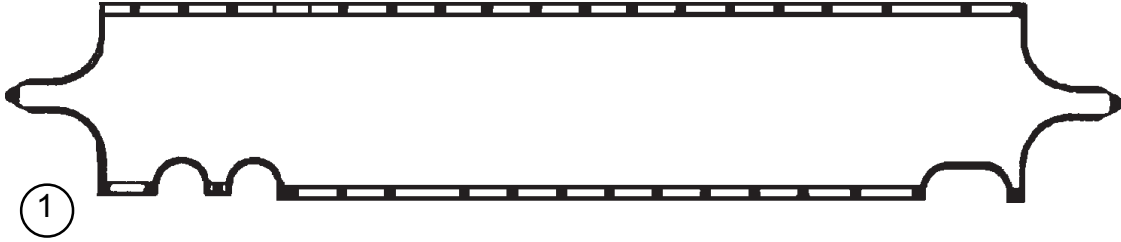

- 1 - Trampoline d'ailes x 2/Trampoline for wings x 2/Trampoline für Wing x 2
 18025095 : blanc/White/Weiß 18025295 : Bleu/Blue/Blau 18025895 : Mesh/Netz
 2 - Assise compl. ss tramp./Bare wing compl. w/o tramp./Wing Sitzfläche ohne Tramp.
 21062926 : Gauche/Left/Links 21062921 : Droite/Right/Rechts
 3 - 21062923 : Aile gauche compl. ss tramp./Left wing compl. w/o trampoline/Wing links compl. ohne Tramp.
 4 - 21060311 : Bras d'aile AR compl. / Wing arm rear compl. /Wingarm hinten compl.
 5 - 21060312 / Bras d'aile AV compl. / Wing arm front compl. / Wingarm vorne compl.

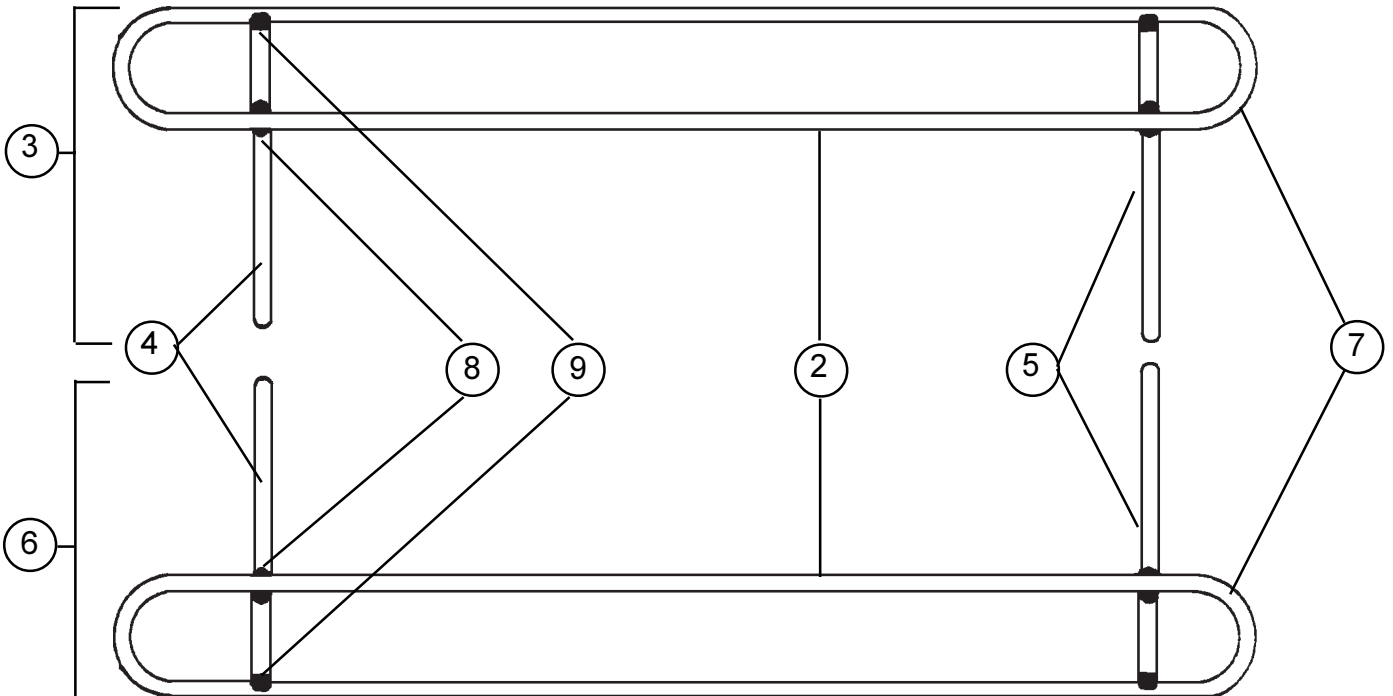

- 6 - 21062924 : Aile droite compl ss tramp/Right wing compl. w/o tramp/Wing rechts compl. ohne Tramp.
 7 - 21062930 : Assise aile nue ss tramp/Bare wing w/o tramp/Außenholm roh ohne Tramp.
 8 - 21041732 : Casting croix de wing/Cross casting wing/ Gußecke Kreuz Wing
 9 - 21041733 : Casting embout de wing/Wing end casting/Wing-Einsteckgußteil



HC 21
Ailes/Wings/Wing

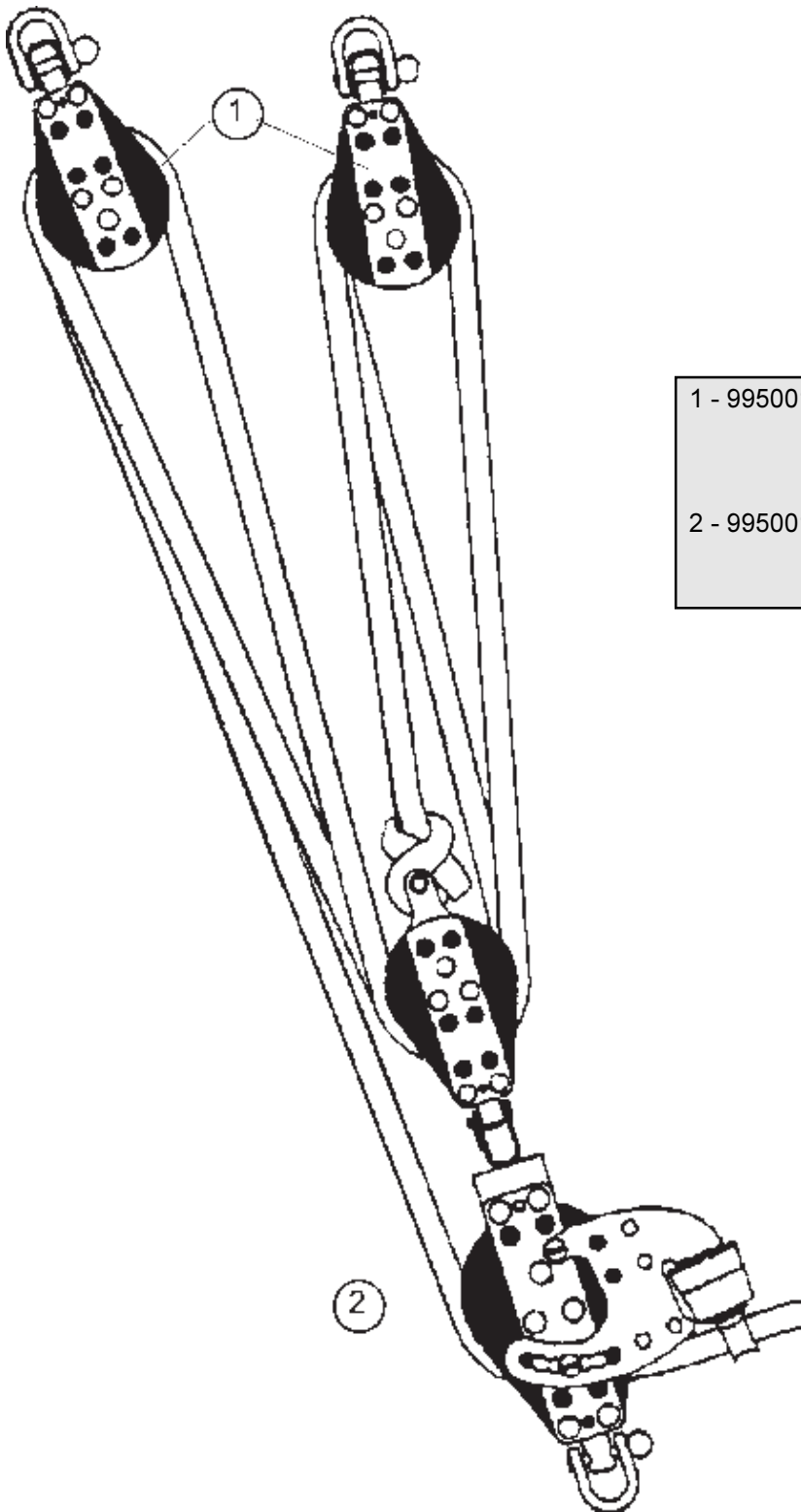

- | | |
|----------------|--|
| 1 - 99500120 : | Poulie bôme double
Boom block double
Zweifacher Baumblock |
| 2 - 99500133 : | Poulie winch Harken
Harken ratchet block
Harken Knarrblock |